

# AnyTone®



ISO 9001 14001



# AT-289P

**TWO-WAY RADIO  
IP67 WATERPROOF**

FC CE 06780 RoHS COMPLIANT

## INSTRUCTION MANUAL



# THANK YOU!

Thank you very much for choosing our *AnyTone*® transceiver. *AnyTone*® transceiver provides you with reliable, clear and efficient communication service.

The transceiver introduces innovative DSP (Digital Signal Processing) baseband processing system to achieve high-fidelity voice processing and encryption. It boasts novelty, best stability, great reliability, nice timbre and long distance communication as well as fashionable design and smooth exterior lines. AT-289P is a cost-effective and multi-functional professional transceiver which meets needs of every walk of life. It is convinced that you will be satisfied with this transceiver's quality and functions. For your full comprehension of the various excellent functions and maintenance, please read the user manual before use.

## **NOTE:**

**When programming the transceiver, read the factory initial data first, then rewrite the frequency and signaling etc., otherwise errors may occur because of different frequency band etc.**

**This product with IP67 waterproof function, can accept water depth 30CM. When transceiver fall into water, after take transceiver out of water, user should shake off the water on microphone and speaker firstly, later can make communication normally.**

User Manual Applied to: AT-289P UHF FM Transceiver  
VHF FM Transceiver

Programming Software: QPS289P

## SAFETY INFORMATION FOR USER

*AnyTone* transceiver is excellently designed with advanced technology. Please observe the following precautions to perform your obligation, prevent personal injury and ensure the safety of transceiver usage.

1. Keep the transceiver and accessories away from children.
2. Please do not try to open or modify the transceiver without permission, non-professionals process may also cause damage.
3. Please use assorted battery and charger to avoid damage.
4. Please use assorted antenna to ensure the communication distance.
5. Please do not expose the transceiver to long period of direct sunlight, nor place it close to heat appliances.
6. Please do not put the transceiver in excessively dusty or humid areas.
7. Do not use harsh chemicals, cleaning solvents to clean the transceiver.
8. Do not transmit without antenna.
9. When using this transceiver, we recommend transmitting for 1 minute then receiving for 4 minutes. Continuous transmitting for long time or working in high power will heat the back of the transceiver. Do not place the transceiver's hot back close to any surface of plastic.
10. If any abnormal odor or smoke detected coming from the transceiver, turn off the power and take off the battery pack and its case. Then contact local *AnyTone* dealers.

### ATTENTION:

All tips above apply to accessories of your *AnyTone* transceiver. If any device can not work normally, please contact local *AnyTone* dealers.

If you use any accessories made by other companies, *AnyTone* Company does not guarantee the operability and safety of the transceiver.

<b>UNPACKING .....</b>	<b>1</b>
Supplied Accessories .....	1
<b>STANDARD ACCESSORIES/OPTIONAL ACCESSORIES .....</b>	<b>2</b>
Standard Accessories .....	2
Optional Accessories .....	2
<b>BATTERY INFORMATION .....</b>	<b>3</b>
Charging Operation.....	3
Charger Applied .....	3
Notice for Charging Battery.....	3
How to Charge .....	4
Normal Charging Tips .....	6
How to Store the Battery.....	6
<b>PREPARATION .....</b>	<b>8</b>
Installing / Removing the Battery .....	8
Installing / Removing the Antenna .....	8
Installing / Removing the Belt Clip .....	9
Installing the Additional Speaker/ Microphone (Optional) .....	9
Installing/ Removing the Hand Strap (Optional).....	10

## ◦ CONTENTS

<b>GETTING ACQUAINTED.....</b>	<b>11</b>
Indicator Status and Beep .....	13
[PF1] & [PF2] Key Default.....	13
<b>BASIC OPERATIONS.....</b>	<b>14</b>
Switch on / off Transceiver.....	14
Adjusting Volume .....	14
Channel Selection.....	14
Group Selection .....	15
Receiving .....	15
Transmitting .....	15
<b>ADVANCED OPERATIONS.....</b>	<b>17</b>
Call 1/Call 2.....	17
Monitor .....	17
Momentary Monitor .....	17
Temporary Deletion of the Interfering Channel .....	18
Squelch Levels Enquiry .....	18
Squelch Levels Setup .....	18
Scan.....	19
Scramble Setup (Encryption).....	19

Squelch off .....	19
Temporary Squelch off .....	20
Talk Around .....	20
Frequency Reverse.....	21
Current Channel Power Enquiry .....	21
TX Power Switch.....	21
Whisper .....	21
Voice Comander (Reduce Noise & Enhance Audio Clarity).....	22
Battery Capacity Enquiry .....	22
Current Channel Enquiry .....	22
Channel Selector Knob Lockout .....	22
<b>BACKGROUND OPERATIONS.....</b>	<b>23</b>
CTCSS / DCS Encode / Decode.....	23
Optional Signaling .....	23
Wide / Narrow Band Setup .....	24
Busy Channel Lockout.....	24
Signaling Relations Setup.....	25
Channel Scan Skip .....	25
TX OFF .....	25

## ◦ CONTENTS

Battery Save Setup .....	25
Time-out Timer .....	26
Time-Out Timer Pre-Alarm .....	26
TOT Re-transmitting Time Setup .....	26
VOX Function.....	26
Priority Scan Setup .....	27
Resume Factory Default .....	27
<b>Programming Software Installing &amp; Starting (TAKES WINDOWS XP AS AN EXAMPLE) ..</b>	<b>29</b>
<b>TECHNICAL SPECIFICATIONS .....</b>	<b>30</b>
<b>TROUBLE SHOOTING GUIDE.....</b>	<b>31</b>
<b>ATTACHED CHARTS .....</b>	<b>32</b>
CTCSS Frequency Chart .....	33
DCS Chart.....	34



Carefully unpack the transceiver. We recommend you to identify the items listed in the following table before discarding the packing material. If any items are missing or have been damaged during shipment, please contact dealers immediately.

### ((( Supplied Accessories

Item	Number	Quantity
Antenna	QA01V(136-174MHz) QA01U(400-480MHz) etc	1
Li-ion Battery Pack	QB-26L	1
Battery Charger	QBC-26L	1
AC adaptor	QPS-01	1
Belt Clip	BC01	1
Instruction Manual		1

## • STANDARD ACCESSORIES/OPTIONAL ACCESSORIES

### Standard Accessories



Antenna\*1  
QA01V (136-174MHz)  
QA01U (400-480MHz) etc.



Li-ion Battery Pack  
QB-26L



Charger  
QBC-26L



AC Adaptor  
(12V/500mA) QPS-01



Belt Clip  
BC01



Instruction  
Manual

\* **Note:** For frequency band of antenna, please refer to label indicated in the bottom of the antenna.

\* **Note:** Car Charger and QBC-26L Charger should be used together.

### Optional Accessories



USB Programming  
Cable PC03



Programming Software  
QPS289P



Earphone  
HS03

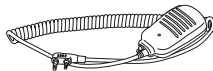

Handheld Microphone  
QHM22



Hand Strap  
GS01



Battery Pack for Car  
charger CPS01



Car Charger CPL01\*2

### ((( Charging Operation

The battery pack is not charged at the factory; please charge it before use.

Charging the battery pack for the first time after purchase or extended storage (more than 2 months) may not bring the battery pack to its normal operating capacity. After fully charging/ discharging cycle for two or three times, the operating capacity will reach its best performance. The battery pack life is over when its operating time decreases even though it is fully and correctly charged. Replace the battery pack.

### ((( Charger Applied

Please use the specific charger appointed by our company. Other models may cause explosion and personal injury. After installing the battery pack, if the radio displays low battery with red flashing lamp or voice prompt, please charge the battery.

### ((( NOTES

- ▼ Do not short the battery terminals or throw the battery into fire. Never attempt to remove the casing from the battery pack, we show no responsibility on any results caused by modifying freely without permission of our factory.
- ▼ The ambient temperature should be between 5°C and 40°C while charging is in progress. Charging outside this range may not fully charge the battery.
- ▼ Always switch OFF the transceiver equipped with a battery pack before charging. Otherwise, it will interfere with correct charging.
- ▼ To avoid interfering the charging, please do not cut off the power or take out the battery during charging.

## • BATTERY INFORMATION

- ▼ Do not recharge the battery pack if it is already fully charged. This may shorten the life of the battery pack or damage the battery pack.
- ▼ Do not charge the battery or transceiver if it is damp. Dry it before charging to avoid danger.

### WARNING:

When keys, ornamental chain or other electric metals contact with the battery terminal, the battery may cause damage or hurt bodies. If the battery terminal short circuit it will generate a lot of heat. Take care when carrying and using the battery. Remember to put the battery or radio into insulated container. Do not put it into metal container.



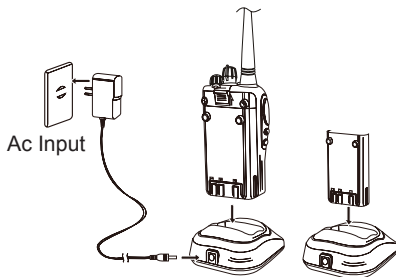

### Ⓜ How to Charge

1. Plug the AC adaptor into the AC outlet, and then plug the cable of the AC adaptor into the DC jack located on the back of the Charger. The Indicator lights orange (1s) and then goes out----waits to charge.
2. Plug the battery or transceiver into the charger. Make sure that the battery terminals are in contact with charging terminals well. The Indicator turns into twinkling red----Pre-charging begins.
3. After pre-charging for about 5 minutes, the indicator will stop twinkling----charging begins.
4. It takes approximately 4 hours to fully charge the battery. When the lamp lights green, the charging is finished. Remove the battery or the transceiver equipped with battery from socket.



**NOTE:** when charging a power-on transceiver equipped with battery, the indicating lamp will not turn into green to show the fully charged status. Only when the transceiver is switched off, can the lamp indicate normally. The transceiver consumes energy when it is power-on, and the charger can not detect the voltage when the battery has been fully charged. So the charger will charge battery in constant voltage and fail to indicate correctly whether the battery has been charged fully.

### 5. Charging Process

Charging Status	Indicator Status
Standby (Self-examine lights orange 1second when power on)	 None
Pre-charging (Pre-charging stage)	 Red light twinkles for about 5 minutes
Charging (Charge in a constant current)	 Lights red for about 4 hours
Fully charged (Charge in a constant voltage)	 Lights green

### 6. LED Indicator:

STATUS	Self-Examine When Power on	No Battery	Pre-charging	Charge Normally	Fully Charged	Trouble
LED	Orange (for 1 second)	None	Red Light Twinkles for 5 Minutes	Red	Green	Red twinkles for a long time

**NOTE:** Trouble means battery heating, battery short-circuit or charger short-circuit.

## • BATTERY INFORMATION

### ((( Normal Charging Tips

1. **Self- Examination:** When charging, orange light twinkles for 1 second and goes out, which means the charger has passed its self-examination and it can charge the battery normally. If the light remains orange or the red light twinkles, it means the charger can not pass its self-examination or charge the battery.
2. **Trickle Pre-Charging:** If red light twinkles when battery is inserted into the charger, it means the remnant voltage is low and the charger is trickle-charging the battery (Pre-Charging Status). The charger will automatically turn into normal charging when the battery reaches a certain electric quantity, And if the red light stops twinkling, it means the remnant voltage meets a certain electric quantity, the charger will charge the battery normally.

#### NOTE:

**Trickle charging (Pre-Charging Status) time can not beyond 30 minutes. If the indicating lamp still twinkles after 30-minute trickle-charging, it means that the charger can not charge the battery. Please check whether the battery or charger is damaged.**

### ((( How to Store the Battery

1. If the battery needs to be stored, keep it in status of 50% discharged.
2. It should be kept in low temperature and dry environment.
3. Keep it away from hot places and direct sunlight.

### **WARNING:**

- ▼ Do not short circuit battery terminals.
- ▼ Never attempt to remove the casing from the battery pack.
- ▼ Never assemble the battery in dangerous surroundings, spark may cause explosion.
- ▼ Do not put the battery in hot environment or throw it into fire, it may cause explosion.

## • PREPARATION

### ((( Installing / Removing the Battery

1. Match the three grooves of the battery pack with the corresponding guides on the back of the transceiver, and then push it.
2. Press the battery pack until the release latch on the top of the transceiver locks. After hearing a “click” sounds, the battery has been locked.
3. To remove the battery pack, slide up the release latch and remove the pack away from the transceiver.

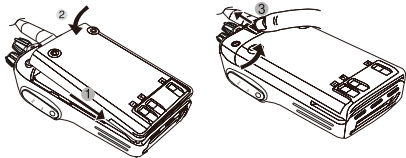

### ((( Installing / Removing the Antenna

#### ■ Installing the Antenna:

Screw the antenna into the connector on the top of the transceiver by holding the antenna at its base and turning it clockwise until secure.

#### ■ Removing the Antenna:

Turn the antenna anticlockwise to remove it.

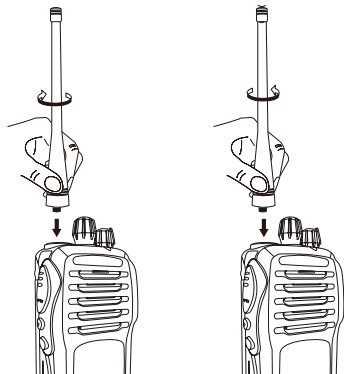



## ((( Installing / Removing the Belt Clip

### ■ Installing the Belt Clip:

Place the belt clip to the corresponding grooves on the back of the transceiver, and then clockwise screw it.

### ■ Removing the Belt Clip:

Anticlockwise turn the screws to remove the belt clip.

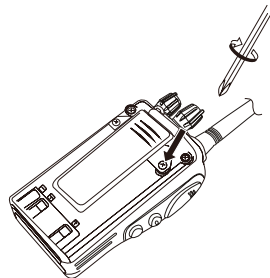

## ((( Installing the Additional Speaker/ Microphone (Optional)

Unveil the MIC-SP jack cover and then insert the Speaker/Microphone plug into MIC-SP jack.

**Note:**

**The transceiver is not completely waterproof while using the Speaker/Microphone.**

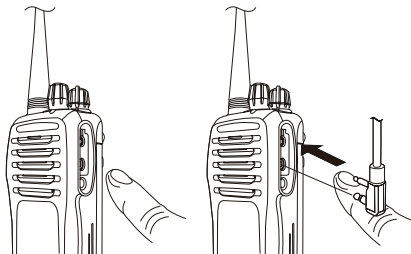

## • PREPARATION

### ((( Installing/ Removing the Hand Strap (Optional)

Slide the loop of the hand strap through the eyelet on the upper rear of the transceiver; then pull the entire hand strap through the loop to secure the hands strap in place and lastly tighten the hands strap.

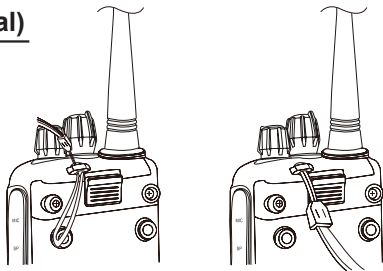

## • GETTING ACQUAINTED

**AnyTone®**  
*We only do best radio!*

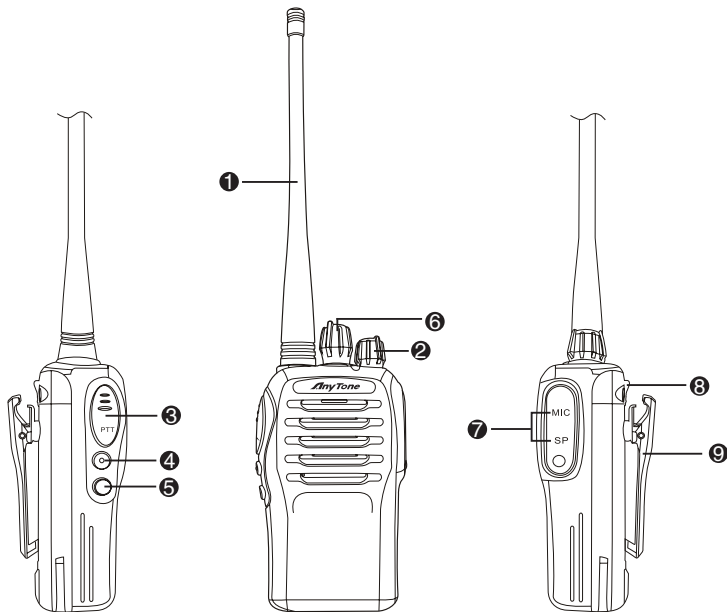

## ◦ GETTING ACQUAINTED

### ❶ Antenna

### ❷ POWER / VOLUME Switch:

Turn clockwise to switch on the transceiver, and turn anticlockwise till hearing “Click” to switch off the transceiver. After switching on the transceiver, turn clockwise to increase the volume and anticlockwise to decrease the volume.

### ❸ PTT Key

When you are making a call, please press and hold this key to speak into the microphone. Release the key to receive.

### ❹ PF1 Key

It can realize different functions by programming.

### ❺ PF2 Key

It can realize different functions by programming.

### ❻ Channel Selector Knob

Turn the selector knob to select desired channel. Turn clockwise to increase channel, anticlockwise to decrease channel.

### ❼ Additional Microphone / Speaker Jack、 Reading / Writing frequency Jack

### ❽ Belt Clip

### ❾ Battery Lock

## Indicator Status and Beep

Warning on low voltage	Transceiver emits a low voltage beep at intervals of 60 seconds, and red light twinkles.
Transmitting/Reading Frequency	Lightens red all the time.
Receiving/Writing Frequency	Lightens green all the time
Scan	Green light twinkles every second.
DTMF Successfully Decoded	Red and green light twinkles at the same time.
Key Operation	Voices "DU" into any function, "DU DU" or beep voice prompt to exit any function

## [PF1] & [PF2] Key Default

Press [PF1]	Battery Capacity Enquiry
Press [PF2]	Squelch off
Press and hold [PF1]	Whisper
Press and hold [PF2]	TX Power Switch

## • BASIC OPERATIONS

### ((( Switch on / off Transceiver

**Switch on Transceiver:** Under power-off state, turn POWER / VOLUME clockwise till hearing "Click" to switch on the transceiver. The transceiver will announce "**Power on**" when power-on.

**Switch off Transceiver:** Under power-off state, turn POWER / VOLUME anticlockwise till hearing "Click" to switch off the transceiver.

### ((( Adjusting Volume

Under power-on state, turn POWER / VOLUME switch to adjust the volume. Turn clockwise to increase the volume, and anticlockwise to decrease the volume. You can press the programmed key of momentary squelch off [PF1] / [PF2] to monitor current volume.

**NOTE:** You can firstly press the programmed key of momentary squelch off [PF1] / [PF2] to monitor the background noise and meanwhile turn POWER / VOLUME to adjust the volume. Under the communicating state, you can adjust volume as per your need more accurately.

### ((( Channels Selection

Under the standby conditions, turn channel selector knob to choose the desired channel, and the transceiver will announce the adjusted channel. Turn clockwise to increase the channel, anticlockwise to decrease the channel.

**NOTE:** The transceiver will emit a voice prompt when current channel is blank.

### ((( Group Selection

There are 128 channels in total which are divided into 8 groups with 16 channels in each group.

After the first channel is selected, press and hold [PF2] to switch on the transceiver. Holding [PF2] for 2 seconds, the transceiver will announce current group number. Under this condition, turn the selector knob to choose the desired group.

**NOTE:** You can enable or disable the group selection function by programming software.

### ((( Receiving

You can hear the transmitting party's calling when the channel you are operating is called and the LED light turns green.

**NOTE:**

**You may not receive the calling if you set a high squelch off level of the transceiver.**

**If current channel has been programmed with signaling, you can only hear the call from a same signaling, other calls can not be heard.**

### ((( Transmitting

Before transmitting, make sure that the channel you want to use is not in busy state through monitoring for a while by pressing the programmed Momentary Squelch off [PF1] / [PF2] key. Under these conditions, press the [PTT] key and speak into microphone. Please keep around 2.5-5cm distance between microphone and your lip. And please speak in normal tone to make the receiver obtain best tone quality.

## • ADVANCED OPERATIONS

The [PF1] and [PF2] keys are programmable. They can realize the following functions by programming software.

**NOTE: When programming the following functions as [PF1] 1S key or [PF2] 1S key, you need to press the [PF1] / [PF2] key for one second till the transceiver beeps and then release the key to realize the programmed function.**

### ((( Call 1/Call 2

Under the standby conditions, press the programmed key of Call1/Call2 ( [PF1]/[PF2] ) to transmit the prestored and selected DTMF signaling.

### ((( Monitor

Under the standby conditions, pressing the programmed key of monitor [PF1] / [PF2], the transceiver emits "DU" beep and then comes into the monitor state. Under these conditions, transceiver will ignore CTCSS / DCS decode and monitor signal of the other party as long as receiving the matched carrier wave. Press this key again, transceiver emits "DU DU" beep and exits the monitor state.

### ((( Momentary Monitor

Under the standby conditions, press and hold the programmed key of momentary monitor [PF1]/



[PF2], the transceiver emits "DU" beep and then comes into monitor state. Under these conditions, transceiver will ignore CTCSS/DCS decode and monitor signal of other party as long as receiving the matched carrier wave. Release this key, transceiver emits "DU DU" beep and exits the monitor state.

### Temporary Deletion of the Interfering Channel

This function can temporarily delete the interfering channel or occupied channel from scan list. When scan stops on one channel, pressing the programmed key of Temporary Deletion of the Interfering Channel, transceiver emits "DU" beep and temporarily deletes this channel from scan list. But the priority channels cannot be temporarily deleted. If only one or two channels are in scan list, this operation is not available. Restart the transceiver to add the temporarily deleted channels into scan list again.

### Squelch Levels Enquiry

Under the standby conditions, pressing the programmed Squelch Levels Enquiry key, transceiver will announce current squelch level.

### Squelch Levels Setup

This function is used to setup the receiving signal intensity. If the receiving signal intensity reaches a certain level, you can hear the other party calling, otherwise transceiver will remain mute.

## • ADVANCED OPERATIONS

Under the standby conditions, pressing the programmed Squelch Levels Setup, transceiver will voice the adjusted squelch level.

### ((( Scan

Scan function can be used in monitoring every channel of current group.

Under the standby conditions, pressing the programmed scan key, transceiver emits "**DU**" beep and comes into scan state. It scans channels in scan list one by one. When one channel receives a matching signal, the transceiver will temporarily stay in this channel till the signal disappears. Pressing the scan key again, transceiver emits "**DU DU**" beep, exits scan and switches the working channel to returned channel which is programmed by users in advance (Please refer to returned channel in the programming software.).

### ((( Scramble Setup (Encryption)

This special audio process can offer a more confidential communication. It makes transceivers of same frequency receive disordered noises only.

Under the standby conditions, pressing the programmed Scramble key, transceiver emits "**DU**" beep and enables Scramble function. Repeat the same operation, transceiver emits "**DU DU**" beep and disables the Scramble function.

### ((( Squelch off

Under the standby conditions, pressing the programmed key of Squelch off [**PF1**] / [**PF2**], the

sqelch circuit is not mute and at present you can hear the background noise. Press this key again, transceiver emits "DU DU" beep, and the sqelch circuit becomes mute. By using this function you can monitor the weaker signal which is hard to receive.

### ((( Temporary Squelch off

Under standby conditions, press and hold programmed key of Temporary Squelch off [PF1]/[PF2], transceiver emits "DU" beep and the sqelch circuit is not mute and at present you can hear the background noise. Release this key, then the transceiver emits "DU DU" and the sqelch circuit is mute. By using this function you can monitor weak signal which is hard to receive.

### ((( Talk Around

Under the standby conditions, pressing the programmed key of Talk Around, transceiver emits "DU" beep and then the current channel comes into Talk Around state. Under these conditions, transceiver will transmit by receiving frequency. Also, the setting code (CTCSS / DCS) will interchange encoding signal as decoding signal.

Press this key again, transceiver emits "DU DU" beep and exits the Talk Around state.

**Note: Under the talk around state, the transceiver can not communicate with other transceivers through repeaters.**

## • ADVANCED OPERATIONS

### ((( Frequency Reverse

Under the standby conditions, pressing the programmed key of Frequency Reverse, transceiver emits "DU" beep and then comes into Frequency Reverse state. After that, the current channel RX frequency will be switched to TX frequency, and the CTCSS or DCS signal which has been setup will be also switched. Pressing this key again, the transceiver exits reverse function with "DU DU" beep.

### ((( Current Channel Power Enquiry

Under the standby conditions, pressing the programmed key of "**Current Channel Power Enquiry**", transceiver announces the current channel power state.

### ((( TX Power Switch

Under the standby conditions, pressing the programmed key of "**TX Power Switch**", transceiver emits BEEP prompt and announces the switched power.

### ((( Whisper

When this function is enabled, other party can hear a higher voice as long as you speak in a lower voice.

Under the standby conditions, pressing the programmed key of "**Whisper**", transceiver emits "DU" beep and enables Whisper function. Pressing the same key again, the transceiver exits Whisper function with "DU DU" beep.

### **((( Voice Compander (Reduce Noise & Enhance Audio Clarity)**

Enable this function to reduce background noise and improve audio clarity, which is especially helpful for long-distance communication.

Under the standby conditions, pressing the programmed key of "**Voice Compander**", transceiver enables the Voice Compander function with "**DU**" beep. Pressing the key again, transceiver exits Voice Compander function with "**DU DU**" beep.

### **((( Battery Capacity Enquiry**

Under the standby conditions, pressing the programmed key of "**Battery Capacity Enquiry**", transceiver announces current battery capacity.

### **((( Current Channel Enquiry**

Under the standby conditions, pressing the programmed key of "**Current Channel Enquiry**", transceiver announces current channel number.

### **((( Channel Selector Knob Lockout**

Enable this function to prevent normal communication failure caused by channel misadjustment.

Under the standby conditions, pressing the programmed key of "**Channel Selector Knob Lockout**", transceiver enables the Channel Selector Knob Lockout function with "**DU**" beep. Press the key again, transceiver exits the Channel Selector Knob Knockout function with "**DU DU**" beep.

## • BACKGROUND OPERATIONS

### ((( CTCSS / DCS Encode / Decode

Users can set independent CTCSS / DCS encode / decode for every channel by programming software.

### ((( Optional Signaling

Users can enable or disable the Optional Signaling in every channel by programming software. This Signaling function is similar to CTCSS/DCS which embodies functions as Selective Call, Group Call, All Call, PTT ID, and Remotely stun and Waken.

1. **PTT ID:** If current channel is edited with PTT ID, the transceiver will send transmitting ID when pressing or releasing PTT key.
2. You can set group call wildcard for each group by programming software . (DTMF character A. B.C.D.\*\*\* or "#").

The caller can call different groups by sending different group call codes. When the receiving party receives a valid ID code, one or all of the characters would be replaced by wildcard characters and the receiving part can realize all call, group call or selective call. It is much easy and flexible to realize all call, group call and etc by using group call code.

**For example:**

**Group code : "C"**

Radio A   Radio B   Radio C   Radio D

ID code of the receiving party is 123   223   235   355.

If the calling party uses "**C23**" to call, Radio A and Radio B will receive the call.

If the calling party uses "**CC5**" to call, Radio C and Radio D will receive the call.

If the calling party uses "**CCC**" to call, All Radios would receive the call..

3. This transceiver is set with 16 groups of DTMF code, users can program and use them flexibly.

### ((( Wide / Narrow Band Setup

On the basis of national conditions, users can set channel spacing as 25K (wide band), 20K (middle band) or 12.5K (narrow band) to communicate on the transceiver by programming software.

This transceiver can realize 25K (wide band), 20K (medium band) or 12.5K (narrow band) as communication way.

### ((( Busy Channel Lockout

When BCL function is enabled, you can not transmit in busy channel. BCL prevents you from interfering with other parties who is using the same frequency point that you select. Under this condition, if you press the [PTT] to transmit, the transceiver will emit beep prompt and return to receiving mode.

Users can set Busy Channel Lockout mode by programming software.

- 1. Repeater (BTL):** Repeat lockout, transmitting is inhibited when current channel receives a matched carrier with different CTCSS/DCS.
- 2. Carrier wave (BCL):** Carrier busy lockout, transmitting is inhibited when current channel receives a matched carrier wave.
- 3. Close:** BCL disabled, you can do transmission under whatever receiving state.

## ◦ BACKGROUND OPERATIONS

### ((( Signaling Relations Setup

Users can set relations between CTCSS/DCS signal and DTMF signal by programming software.

**AND:** Only when a matching CTCSS/DCS signal and a DTMF signal are received, can calling of other party be heard.

**OR:** As long as a matching CTCSS/DCS signal or a DTMF signal is received, calling of the other party can be heard.

### ((( Channel Scan Skip

Users can choose whether to set current channel as Scan Skip by programming software. Transceiver will skip current channel during scan when it is set as Scan Skip.

### ((( TX OFF

Users can enable or disable the Transmitting Inhibited Function in current channel by programming software. Once this function is enabled, [PTT] key becomes invalid key, and the transceiver only works in receiving mode.

### ((( Battery Save Setup

When this function is enabled, the transceiver can efficiently reduce battery consumption. The transceiver will automatically switch on Battery Save Function when not receiving any signal or making any operations. But when the transceiver receives a matching signal or make operations, it



will automatically exit this function.

### ((( Time-out Timer

The purpose of the Time-out Timer is to prevent any caller from using a channel for an extended period of time. If you continuously transmit for a period of time that exceeds the programmed time set in advance, the transceiver will stop transmitting with voice prompt.

Users can set TOT timer by programming software.

### ((( Time-Out Timer Pre-Alarm

The Time-Out Timer Pre-Alarm is to alarm users that overtime transmission is going to happen.

Users can program desired TOT Pre-Alarm time by programming software.

### ((( TOT Re-transmitting Time Setup

TOT Re-transmitting Time is the interval between the stopped overtime transmission and allowed re-transmission. Pressing PTT key before Re-transmitting time, the transceiver will inhibit transmission with voice prompt.

Users can set desired TOT Re-transmitting Time by programming software.

### ((( VOX Function

When this function is enabled, you can begin transmitting by fitted high voice, no needing to press

## ◦ BACKGROUND OPERATIONS

the [PTT] key.

Users can enable or disable the VOX function by programming software.

### ((( Priority Scan Setup

This transceiver can be set with two priority channels at the same time. Users can set the desired priority scan by programming software. If transceiver set priority scan, under scanning and receiving no signal state, it will scan every channel and also test priority channel at a time. When the non-priority channel receives signal, it will test priority channel according to flyback time A and flyback time B setup by users.

### ((( Resume Factory Default

Once transceiver works abnormally for wrong operations or wrong programming, users can start this function to resume all functions and channels as Factory Default.

Press [PTT] and [PF1] key synchronously to switch on transceiver. Holding the two keys for more than 1 second, the transceiver will resume Factory Default after announcing current channel number.

## PROGRAMMING SOFTWARE INSTALLING & STARTING (TAKES WINDOWS XP AS AN EXAMPLE)

**AnyTone®**  
*We only do best radio!*

1. Double-click "QPS289P SETUP.EXE", and then install the software as per computer instructions.
2. Click "START" menu, select and click "USB TO COM PORT" in the "QPS289P" program from "ALL PROGRAM".
3. Connect the optional cable PC03 to the USB port in PC device and connect the transceiver with the other end of cable.
4. Double click "QPS289P" setup short-cut icon or click "START" menu to choose QPS289P entry in the QPS289P program from "ALL PROGRAMS" menu (Refer to picture 1).
5. As per computer command, choose serial port "COM Port" firstly (Refer to picture2), then click OK to start programming software.

### TIPS:

In one individual computer, users need to choose different COM Port number when USB cable is connected with different USB port.

To program frequency, power on the transceiver firstly. Do not power on/off the transceiver when it is connected with computer. Otherwise, the transceiver can not read or write frequency well. If this condition happens, please firstly close the programming software, disconnect USB Connector(PC03) from computer, then, connect the USB connector with

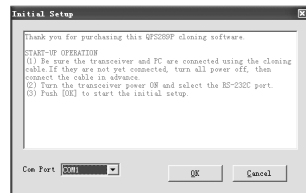

(picture 1)

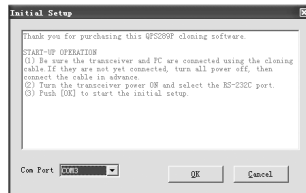

(picture 2)

- **PROGRAMMING SOFTWARE INSTALLING & STARTING(TAKES WINDOWS XP AS AN EXAMPLE)**

computer again and select the corresponding COM Port to start the programming software.

So, please power on the transceiver before connecting with the computer. Do not reset the transceiver when the transceiver is connected with the computer.

**NOTE: The programming software of this transceiver has identifying system. Therefore, when you start programming software at the first time, you should connect the transceiver and then you can run the software, otherwise the software cannot be run.**

## • TECHNICAL SPECIFICATIONS

**AnyTone®**

*We only do best radio!*

General	
Frequency Range	VHF:136-174MHz VHF:350-390MHz UHF:400-480MHz UHF:450-520MHz
Channel Capacity	128 channels
Channel Spacing	25KHz (Wide Band) 20KHz(Middle Band) 12.5KHz (Narrow Band)
Phase-locked Step	5KHz, 6.25KHz
Operating Voltage	7.4V DC $\pm 20\%$
Battery Life	More than 14 Hours (1500mAh), by 5-5-90 work cycle
Frequency Stability	$\pm 2.5$ ppm
Operating Temperature	$-20^{\circ}\text{C} \sim +55^{\circ}\text{C}$
Size	260×60×35mm (with battery pack, antenna)
Weight	208 g (with battery pack, antenna)

Receiving Part(ETSI EN 300 086 Standard Test)		
	Wide band	Narrow band
Sensitivity(12dB SINAD)	$\leq 0.25\mu\text{V}$	$\leq 0.35\mu\text{V}$

Adjacent Channel Selectivity	$\geq 70\text{dB}$	$\geq 60\text{dB}$
Intermodulation	$\geq 65\text{dB}$	$\geq 60\text{dB}$
Spurious Rejection	$\geq 70\text{dB}$	$\geq 70\text{dB}$
Audio Response	+1~-3dB (0.3~3KHz)	+1~-3dB (0.3~2.55KHz)
Hum & Noise	$\geq 40\text{dB}$	$\geq 36\text{dB}$
Audio Distortion	$\leq 5\%$	
Audio Power Output	1000mW/10%	

Transmitting Part(ETSI EN 300 086 Standard Test)		
	Wide band	Narrow band
Power Output	5W/2W/0.5W	
Modulation	16KΦF3E	11KΦF3E
Adjacent Channel Power	$\geq 70\text{dB}$	$\geq 65\text{dB}$
Hum & Noise	$\geq 40\text{dB}$	$\geq 36\text{dB}$
Spurious Emission	$\leq -36\text{dB}$	$\leq -36\text{dB}$
Audio Response	+1~-3dB (0.3~3KHz)	+1~-3dB (0.3~2.25KHz)
Audio Distortion	$\leq 5\%$	

## • TROUBLE SHOOTING GUIDE

Problem	Corrective Action
No Power	<p>A. The battery pack may be exhausting. Recharge or replace the battery pack.</p> <p>B. The battery pack may not be installed correctly. Remove the battery pack and install it again.</p> <p>C. The power switch is broken; send it to local dealers to repair.</p> <p>D. Battery touch is broken; send it to local dealers to repair.</p>
Battery power dies shortly after correctly charging.	The battery pack life is finished. Replace the battery pack with a new one.
Transceiver cannot scan	The channels are not in scan list. (Professionals set it.)
All band noisy after programmed or green light always lightens	Turn on squelch when programmed. Non-professionals are advised not to adjust this function.
No sound after using microphone for a while	Earphone jack is broken. (Please contact with local dealers to repair it.)
Communication distance becomes short, and it is low sensitivity	<p>A. Check whether the antenna is in good condition and the antenna base do not come adrift.</p> <p>B. Users select wrong frequency type which is not in accord with this transceiver when programming.</p> <p>C. Whether it has set in low power output. (Please contact with local dealers to repair it.)</p>

## • TROUBLE SHOOTING GUIDE

**AnyTone®**

*We only do best radio!*

Cannot talk to or hear other members in your group	A. Different frequency or channel, please change it. B. Different CTCSS / DCS please reset it. C. Out of communication range.
Can not power on or frequent power-off	Check whether the battery touch is out of sharp or broken.
The receiver gets low or intermittent voice from the caller	Check weather the MIC is stoppage. (Otherwise, please contact with local dealers to repair it.)
Unstable communication with loud background noise	Out of communication range or obstruct by tall buildings or in basement and so on.
Loudspeaker become lower or with "ka ka" sound after using a certain time	Check whether the loudspeaker net is broken. Iron powder or sundries is in the loudspeaker. (Please contact with local dealers to repair it.)
Receive voice from the other party but can not transmit	Check [PTT] key. (Please contact with local dealers to repair it.)
Receiving Indicator (green light) lightens but no sound	A. Low volume, please turn on clockwise. B. Loudspeaker is broken. (Please contact with local dealers to repair it.) C. Earphone jack is broken. (Please contact with local dealers to repair it.) D. Volume switch is broken. (Please contact with local dealers to repair it.)

## • ATTACHED CHART

### ((( CTCSS Frequency Chart

1	67.0	12	94.7	23	141.3	34	179.9	45	225.7
2	69.3	13	100.0	24	146.2	35	183.5	46	229.1
3	71.9	14	103.5	25	151.4	36	186.2	47	233.6
4	74.4	15	107.2	26	156.7	37	189.9	48	241.8
5	77.0	16	110.9	27	159.8	38	192.8	49	250.3
6	79.7	17	114.8	28	162.2	39	196.6	50	254.1
7	82.5	18	118.3	29	162.5	40	199.5		
8	85.4	19	123.0	30	167.9	41	203.5		
9	88.5	20	127.3	31	171.3	42	206.5		
10	91.5	21	131.8	32	173.8	43	210.7		
11	94.8	22	136.5	33	177.3	44	218.1		



((( DCS Chart

1	017	18	073	35	165	52	261	69	356	86	464	103	632
2	023	19	074	36	172	53	263	70	364	87	465	104	645
3	025	20	114	37	174	54	265	71	365	88	466	105	654
4	026	21	115	38	205	55	266	72	371	89	503	106	662
5	031	22	116	39	212	56	271	73	411	90	506	107	664
6	032	23	122	40	<b>217</b>	57	274	74	412	91	516	108	703
7	036	24	125	41	223	58	<b>305</b>	75	413	92	523	109	712
8	043	25	131	42	225	59	306	76	423	93	526	110	723
9	047	26	132	43	226	60	311	77	<b>425</b>	94	532	111	731
10	050	27	134	44	243	61	315	78	431	95	<b>534</b>	112	732
11	051	28	<b>135</b>	45	244	62	325	79	432	96	546	113	734
12	053	29	143	46	245	63	331	80	445	97	565	114	743
13	054	30	145	47	246	64	332	81	446	98	606	115	754
14	<b>055</b>	31	152	48	251	65	343	82	452	99	612	116	<b>765</b>
15	065	32	155	49	252	66	<b>345</b>	83	454	100	624		
16	071	33	156	50	<b>254</b>	67	346	84	455	101	627		
17	072	34	162	51	255	68	351	85	462	102	631		

**NOTE:** 1. "N" stands for positive code. "I" stands for inverted code. 232 groups of DCS in total.  
2. Overstriking marks are non-standard DCS.



***AnyTone***<sup>®</sup>  
*We only do best radio!*

---